



# MEGALITE

Medium duty steel panel formwork in imperial sizes



// Light, durable, handled without crane



// Table of contents:

Features	2
Advantages	4
Solutions	5
Basic components	7







**MEGALITE** Medium duty panel formwork



## // Features

- ▶ Modular wall and column formwork in **imperial measurements**.
- ▶ Ideal for use on any **vertical concrete structure in building construction** (walls, columns, pilasters, wall intersections, foundations).
- ▶ Handset system with light panels: **7 lbs/feet<sup>2</sup>**.
- ▶ **Maximum versatility**, combining multifunctional universal panel with the lateral holes on standard panels.
- ▶ Form face, phenolic or composite board, riveted to the **metal frame**.



▶ Handset erection of the formwork

### ▶ **Maximum concrete pressure:**

- **1250 psf**

### ▶ **2 rows of tie rods in height up to 8'.**

### ▶ **Height range: 8', 6' and 4'.**



▶ Forming of high walls with formwork gangs

### ▶ **Gangs can be laid out every 6" by combining different panels.**

### ▶ **Width range: 30", 24", 18", 12" and 6".**

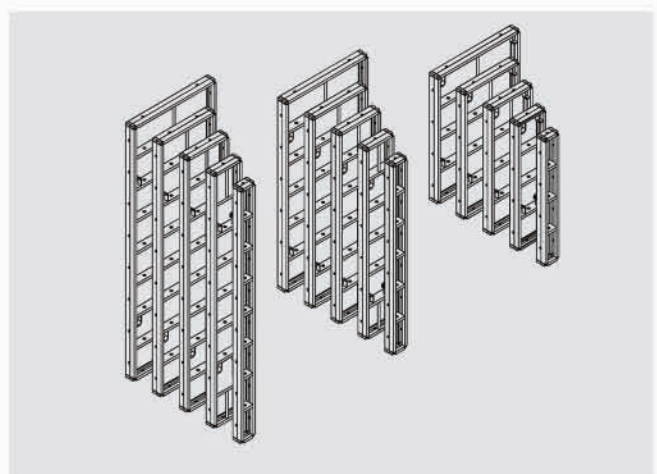
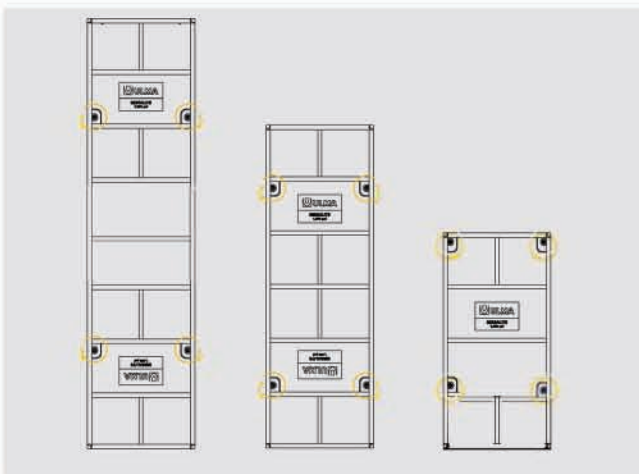



**MEGALITE** Medium duty panel formwork



► **Columns with universal panel:**

- Column solution with panels of 6" x 6" to 30" x 30", adjustable in 1" increments.
- Wider columns are possible by joining panels longitudinally.



► Different column solutions with MEGALITE.

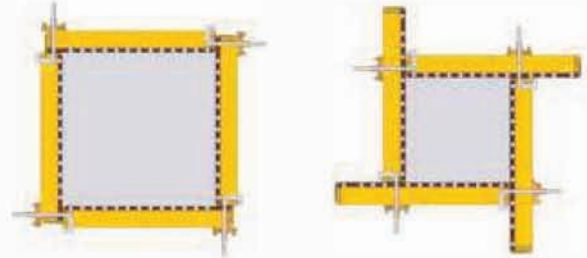

► Columns from 6" x 6" to 27" x 27" adjustable in 1" increments.

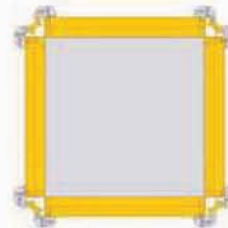

► Maximum column of 30" x 30", using universal panels with outside corners tied with fixed clamps

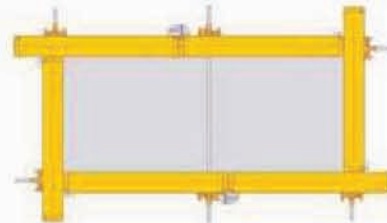

► Large columns up to 57"

## Panel connection: Clamps

- Fast and simple connection with one single strike of hammer.

### Fixed Clamp



► Tying connecting panel profiles with fixed clamp



► Fixed clamps on formwork corner

### Adjustable Clamp



► Connecting panel profiles with adjustable clamp



► Can be used to join panels together with a wood or steel filler up to 4" wide placed between the panels





## // Advantages

- ▶ **Light panels** for easy handling.
- ▶ **Excellent concrete finishes.**
- ▶ **Versatile.** All kinds of solutions combining perpendicular connection wall panels with lateral holes and universal panels with **multi-punched ribs**.
- ▶ **Quick and easy connection** with MEGALITE Clamp.
- ▶ **High strength panels** with only two ties.
- ▶ **Lifting hook** for the lifting of assembled gangs
- ▶ **Long-lasting.** Steel frames with reinforced corners.



▶ Safe working platforms



▶ Strong steel frames



▶ Wall solutions with Universal panel





## // Solutions

- 1 Panel connection: Clamps
- 2 Gang lifting
- 3 90° Corners
- 4 Hinged corners
- 5 Pilaster
- 6 90° wall intersections
- 7 Bulkheads
- 8 Fillers
- 9 Columns
- 10 Climbing support brackets
- 11 Walkway platforms / Guardrails

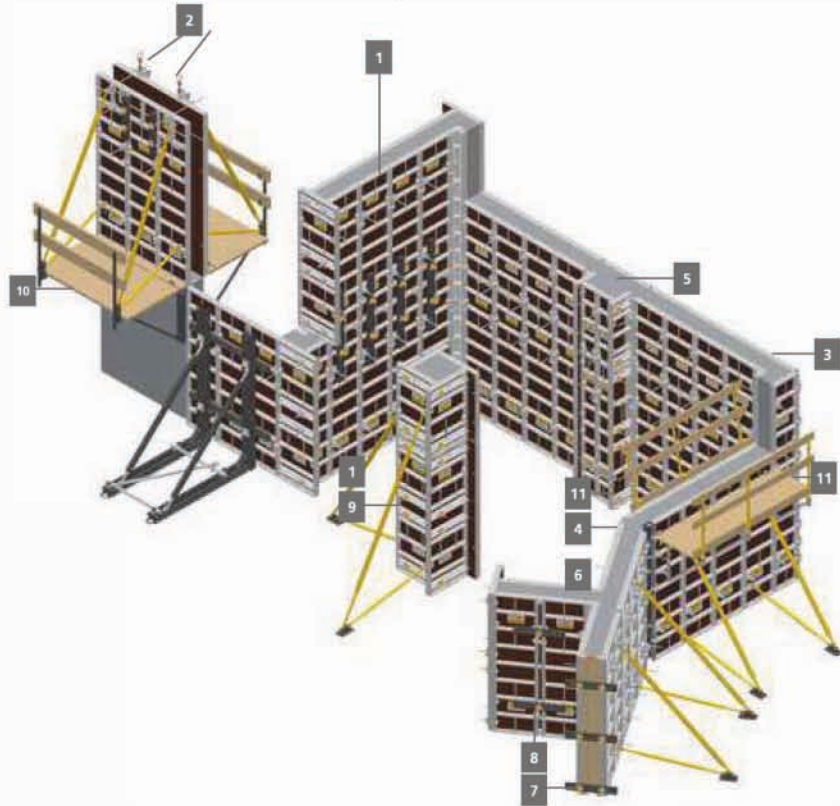

### Gang lifting

The MEGALITE Lifting Hook is an accessory component for lifting gangs using a crane. A minimum of two Hooks must be used for gang lifting.

The lifting hook has a maximum safe working load of **2650 lbs.**



1.- Opening



2.- Placing



3.- Fastening

► Basic installation of the lifting hook to the panel's profile



► Lifting of gang

### 90° Corners

► Outside face



With universal panel



With outside corner

► Inside face



With rigid Inside corner

### Hinged corners

Hinged corners on the inside and outside of the wall. Angle between 75° and 180°







**MEGALITE** Medium duty panel formwork



### Pilasters

▶ With Universal hinged corner UHC

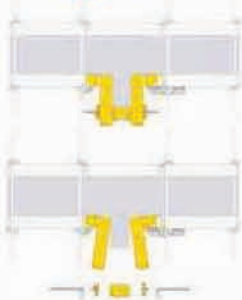

▶ With Universal Panel



▶ With Waler



▶ Pilaster in corner with universal hinged corner



### Compensations

▶ Job built filler 0<x<2"



▶ Filler 2" & 4"



▶ Job built filler 2"<x<4"



### Bulkheads

▶ With Universal Panel



▶ With Waler



### 90° wall intersections

▶ Combining the Inside Corner with the different panel widths



### Climbing support brackets



▶ The bracket supports the walkway platform and the formwork.

### Columns

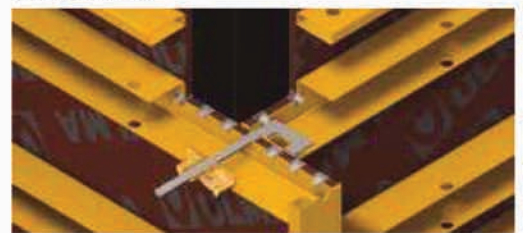

▶ Solved with Universal panels, connected with Bulkhead hooks and Plate nuts 15



### Walkway platforms / Guardrails



▶ Walkway brackets & guardrail posts ▶ Total and collective protection



**MEGALITE** Medium duty panel formwork



**Basic components**

PANELS		
ML panel 8' x 24"	1920455	108
ML panel 6' x 24"	1920456	83.8
ML panel 4' x 24"	1920457	57.8
ML panel 8' x 18"	1920473	91.3
ML panel 6' x 18"	1920458	70.5
ML panel 4' x 18"	1920459	48.5
ML panel 8' x 12"	1920474	72.8
ML panel 6' x 12"	1920460	56
ML panel 4' x 12"	1920461	37.9
ML panel 8' x 6"	1920475	54
ML panel 6' x 6"	1920462	41
ML panel 4' x 6"	1920463	27.8

- Forming face: phenolic or composite board

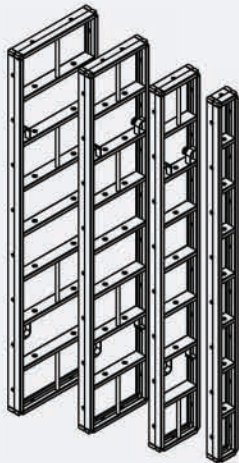

ML universal panel 8' x 30"	1920480	145
ML universal panel 6' x 30"	1920490	110
ML universal panel 4' x 30"	1920500	80.2

- Forming face: phenolic or composite board

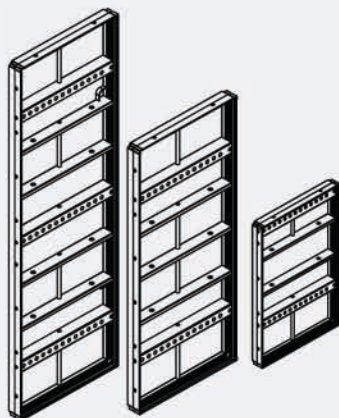

CORNERS		
ML inside corner 8" x 8"	1920242	84.4
ML inside corner 8" x 8" 6'	1920246	64.8
ML inside corner 8" x 8" 4'	1920250	45.2
ML outside corner 8'	1920082	48.7
ML outside corner 6'	1920080	36.6
ML outside corner 4'	1920075	24.5
ML hinged outside corner 8'	1920128	80
ML hinged outside corner 6'	1920140	60
ML hinged outside corner 4'	1920152	40.1
ML hinged inside corner 8'	1920130	121
ML hinged inside corner 6'	1920146	90.6
ML hinged inside corner 4'	1920158	60.6
ML universal hinged corner 8'	1920098	143
ML universal hinged corner 6'	1920100	105.4
ML universal hinged corner 4'	1920110	81.6

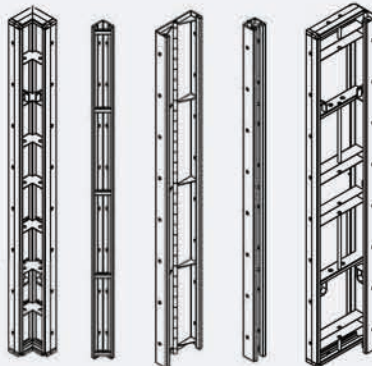

COMPENSATIONS		
ML compensation 2" x 8"	1920050	39.7
ML compensation 2" x 6"	1920052	29.8
ML compensation 2" x 4"	1920054	20.1
ML compensation 4" x 8"	1920067	47.8
ML compensation 4" x 6"	1920072	36.8
ML compensation 4" x 4"	1920059	25.4



CONNECTORS - LIFTING		
Lifting hook	1920835	17.6



Megalite Fixed Clamp	1920818	2,2
----------------------	---------	-----



Megalite Adjustable Clamp	1920851	8.8
---------------------------	---------	-----

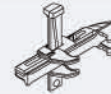

PIPE BRACES		
Pipe brace head type B	U190025	2.2
Pipe brace shoe	1900144	10.9

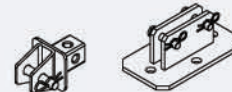

Pipe brace 1.1-1.7 (3'-7" to 4'-11")	1900134	17
Pipe brace 2.4-3.5 (7'10" to 10'9")	1900123	53.4
Pipe brace 3.6-4.8	1908168	95.5
Pipe brace 5.1-6	1900147	112



WORKING PLATFORMS - SAFETY ELEMENTS		
MEGALITE walkway bracket	1920041	20.1
MEGAFORM walkway bkt post (black)	1904311	7.5

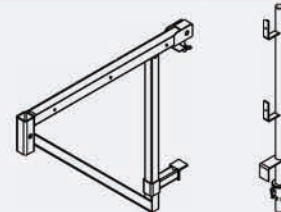

MEGALITE handrail bracket	1920854	3.3
---------------------------	---------	-----

